

4 Channel PVT

Features

- ★ Transmission Distance: 800 Meters
- ★ Input Power Supply: 100~240V AC(50~60HZ)
- ★ Output Voltage: DC 24V 3A
- ★ Output ripple: Less than 240MV
- ★ Video input impedanc: BNC:75Ω

Model	S-4PVT
Transmission Distance	800 Meters with interference-free
Wire Category	Coaxial Cable:75-5 (RG60, RG 59 recommended) or higher
Video transmission bandwidth	0.5MHZ-10MHZ
Input voltage	110~220V 20%, the convert between 110V and 220V 20%
Input frequency	50MHZ-60MHZ 20%
Leakage current	110V~220V 20% Less than 3.5MA
Output voltage	DC 24V 3A
Output voltage adjustment range	24~28V
Output current	thr rated 800MA, MAX 1000MA
Output ripple	Less than 240MV
Overload protection	Output current more than 800MA, Protection circuit disconnect the load, and then automatic connection after the working current to be normal
Video input	1.0v-vP Automatically adapted
Video input impedanc	Coax BNC:75Ω
Working Temperature	-50℃~ +50℃
Working Humidity	10%--90%
Material	Metal

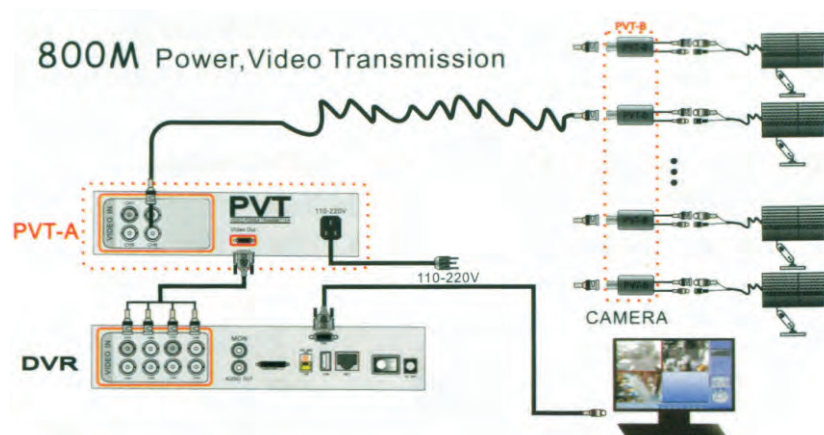

Power Solution on Coaxial Cable